



Express Frame Tent 20 x 30

Structural evaluation of the Toptec Express tents with 7 ft leg height
in accordance with IBC 2012 and ASCE 7-10

Evaluated for use in the following conditions:

1. Risk / Occupancy Category I
2. Wind Speed 100 mph, Exposure Category B
3. Temporary Structure - (mean recurrence interval ≤ 2 yr = .6 σ)
4. Enclosed Structure
5. Not designed for
 - snow loading,
 - flood hazard areas or,
 - areas subjected to escarpment effects.

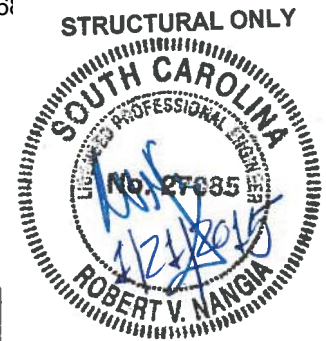

ROBERT V. NANGIA P.E.
7423 HOLLOW RIDGE DR.
HOUSTON, TX 77095

This drawing was produced
by and/or under my
direct supervision

The professional engineer seal on this cover page refers to the calculation sheets contained within this document and to any Appendix or Table sheets that support this document. Any other drawings and documents may require a separate seal for coverage not provided here.

Certification of this document only shows that the Professional Engineer of that particular state is in agreement with the report's contents. It does not, however, imply that the structure is generally suitable for use within that state, or that every installation is covered by this report.

The information and illustrations contained within this document remain the sole property of TopTec Products, LLC and are to be treated as confidential.

The professional engineers seal, affixed on this document, signifies a responsibility for the structural adequacy of the design of the structure in the completed project. The content contained within this document does not encompass means, methods and safety of erection.

All data, designs, technical representations, engineering calculations and illustrations whether written or implied may not be reproduced in whole or in part nor distributed, used in manufacturing, design or display without the express written consent of TopTec Products, LLC.

Retention of this document shall constitute acceptance of these terms and conditions.

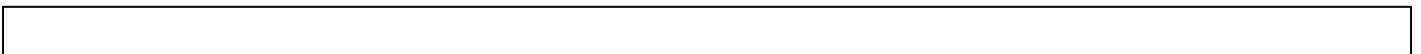



TopTec Events Tents
7601 Highway 221
Moore, SC. 29369
(800) 845-2830
(864) 804-5901

This page intentionally left blank



TopTec Events Tents
7601 Highway 221
Moore, SC. 29369
(800) 845-2830
(864) 804-5901

Table of Contents

1. Summary and Recommendations
 2. Project Parameters
 3. Determination of Loads
 - Dead Load
 - Live Load
 - Roof Live Load
 - Snow Load
 - Wind Load
 4. Load Combinations
 - 5a. Beam Profile Design
 - 5b. Post Profile Design
 6. Guy Strap Assembly Check
- Appendix A - Computer Model INPUT
Appendix B - Computer Model OUTPUT

Revision Log

<u>Rev</u>	<u>Rev. Date</u>	<u>Description</u>
0	15 Jan 14	- Original Issue



TopTec Events Tents
7601 Highway 221
Moore, SC. 29369
(800) 845-2830
(864) 804-5901

This page intentionally left blank



1. Summary and Recommendations

This document, based on technical background information as provided by TopTec Products, LLC, covers the structural evaluation of the aluminum frame style structure in accordance with U.S. Building Code requirements. The specifications outlined in the Structural Engineering Institute / American Society of Civil Engineers (SEI/ASCE7) "Minimum Design Loads for Buildings and Other Structures" were followed in determining the integrity of the structure. This document is intended to serve as a basis for the acceptability of this temporary, stand-alone, open or enclosed structure under standard design wind loads at exposure category B.

Lightweight Design Inc. compiled this document based on the existing frame tent system with reference to the applicable building codes in the U.S. This report includes the load cases and combinations used in the analysis and gives an indication as to the wind exposure for which the structure is suitable. Certification of this document only shows that the Professional Engineer of that particular state is in agreement with the report's contents. It does not, however, imply that the structure is generally suitable for use within that state, or that every installation is covered by this report.

As this document was compiled based on design information as provided by TopTec Products, LLC, the summary and recommendations for this structure and contained within this document can only be valid if the structure is erected with original TopTec parts and components.

Computer-aided structural frame analysis were involved in the course of the investigation. Different load combinations were considered to identify the critical aspects of the design. Member and detail checks were established to derive the conclusions for the entire report.

For each different tent width, iteration of calculations were performed to determine the maximum suitable wind speed for each different exposure category. As such, we have arrived at the following conclusions and recommendations;

1.1 Wind Speed Rating

- Wind Speed 120 mph, 3-second gust
- Exposure Category B (urban or suburban terrain)
- Risk Category I
- Mean Recurrence Interval 2 years
- Velocity Pressure $q_h = 10.09 \cdot \text{psf}$ at mean roof height, $h = 9.61 \cdot \text{ft}$

For the above mentioned wind speed, exposure category, and return period (or mean recurrence interval, MRI), the structure satisfies the requirements of the "American Society of Civil Engineers Minimum Design Loads for Buildings and Other Structures (ASCE 7), as well as the International Building Code (IBC).



Exposure Categories (IBC)

1609.4.3 Exposure categories. An exposure category shall be determined in accordance with the following:

Exposure B. Exposure B shall apply where the ground surface roughness condition, as defined by Surface Roughness B, prevails in the upwind direction for a distance of at least 2,600 feet (792 m) or 20 times the height of the building, whichever is greater.

Exception: For buildings whose mean roof height is less than or equal to 30 feet (9144 mm), the upwind distance is permitted to be reduced to 1,500 feet (457 m).

Exposure C. Exposure C shall apply for all cases where Exposures B or D do not apply.

Exposure D. Exposure D shall apply where the ground surface roughness, as defined by Surface Roughness D, prevails in the upwind direction for a distance of at least 5,000 feet (1524 m) or 20 times the building, whichever is greater. Exposure D shall extend inland from the shoreline for a distance of 600 feet (183 m) or 20 times the height of the building, whichever is greater.

Surface Roughness Categories (IBC)

1609.4.2 Surface roughness categories. A ground surface roughness within each 45-degree (0.79 rad) sector shall be determined for a distance upwind of the site as defined in Section 1609.4.3 from the categories defined below, for the purpose of assigning an exposure category as defined in Section 1609.4.3.

Surface Roughness B. Urban and suburban areas, wooded areas or other terrain with numerous closely spaced obstructions having the size of single-family dwellings or larger.

Surface Roughness C. Open terrain with scattered obstructions having heights generally less than 30 feet (9144 mm). This category includes flat open country, grasslands, and all water surfaces in hurricane-prone regions.

Surface Roughness D. Flat, unobstructed areas and water surfaces outside hurricane-prone regions. This category includes smooth mud flats, salt flats and unbroken ice.

1.2 Dead Loads

Dead loads are defined as the weights of the materials of construction and fixed service equipment. For this analysis the weight of the frame and fabric have been accounted for.

1.3 Hanging Dead Loads

Hanging dead loads are ancillary loads that typically are hanging from the structure, but not necessarily part of the standard structure. These can be due to electrical and mechanical fixtures (lighting, HVAC, suspended items, etc.). In the case of this structure, no hanging dead loads are considered.

The owner of the structure shall not hand, or otherwise affix, additional loads to this structure without a review by an engineer qualified to make said review. Additionally, prior to adding load to this structure, the owner shall get a written confirmation by the qualified engineer as to the magnitude and location of the load, or loads, being applied.

1.4 Live Loads

Live loads are loads produced by the use and occupancy of the building are found on Table 1607.1 (IBC). In the case of this structure, there are no additional live loads.

1.5 Snow Loads

This tent structure is assumed to be erected on a temporary basis, in locations, and during seasons, where snow loading is not expected. No snow loading value has been applied in this analysis ($P_s = 0$ psf).

If a snow event is expected or is likely to occur while the fabric is still in place, then measures should be provided to ensure snow removal or melting. Furthermore, the prescribed gradient of the roof fabric should be maintained to allow for smooth drainage and to prevent the potential for ponding of melt water.



1.6 Seismic Loads

Due to the low mass of the structure, seismic base shear does not control over wind loading shear and thus has not been included in this analysis.

1.7 Base Reactions

The maximum reactions at the foundations/supports due to the factored load and exposure category are given in the table below, per base plate, per frame.

Express Tents - Post					
Size	Post	Vertical - gravity	Vertical - Uplift	Horizontal	Req'd Ballast Weight
20 x 30	Corner	535 lbf	103 lbf	137 lbf	377 lbf
	Internal-Side	823 lbf	357 lbf	429 lbf	1215 lbf
	Internal-Hip	790 lbf	30 lbf	164 lbf	358 lbf

* See Section 07 - Guy Cable Design for reactions load at Guy Cable.

NOTE: Foundations, by others, are required to support column loads. The structure should be set on firm and unyielding ground. This ground should sufficiently contain the bearing pressures of the base plates as well as the tractive forces of the anchors. A foundations engineer must verify ground conditions on a site-by-site basis and provide appropriate bearing plate sizes to accommodate column loads:

1.8 Installation Requirements

It is understood that the responsibility of proper installation according to the plans rests upon the installation contractor. This includes, but is not limited to, ensuring the following:

- that the cables are always held taut,
- that the fabric is stretched tight enough to prevent the development of pockets and to maintain the prescribed roof gradient,
- that purlins are installed securely against rafters to resist calculated loads,
- that base plates are secured to their foundations using anchors. The manufacturer provides a base plate and anchoring plan for the structure as a base starting point for average soil conditions. It is the installer's responsibility to ensure that the anchorage provided will resist the reaction loads as indicated in the tables found in this document.



TopTec Events Tents
7601 Highway 221
Moore, SC. 29369
(800) 845-2830
(864) 804-5901

This page intentionally left blank



TopTec Events Tents
7601 Highway 221
Moore, SC. 29369
(800) 845-2830
(864) 804-5901
www.toptecproducts.com

2. Project Parameters

The Express frame tent structure is made up of 2" aluminum pipe rafters, beams, and posts. These frames are the main supporting elements for the structure. The aluminum alloy is an equivalent to the American alloy 6061-T6 as detailed in the U.S. Aluminum Construction Manual and is the basis of material property and allowable stress determinations.

Building Geometry

	Imperial Dimensions	Metric Dimensions
Frame Width:	$L_{\text{width}} = 20 \cdot \text{ft}$	$L_{\text{width}} = 6.1 \cdot \text{m}$
Frame Length:	$L_{\text{length}} = 30 \cdot \text{ft}$	$L_{\text{length}} = 9.14 \cdot \text{m}$
Peak height (outside):	$z_{20} = 12.5 \cdot \text{ft}$	$z_{20} = 3.81 \text{ m}$
Eave/ Leg height (outside):	$h_e = 6.73 \cdot \text{ft}$	$h_e = 2.05 \text{ m}$



TopTec Events Tents
7601 Highway 221
Moore, SC. 29369
(800) 845-2830
(864) 804-5901
www.toptecproducts.com

This page intentionally left blank



3. Determination of Loads

Dead Load :

The structure dead loads consist of the self weight of the structure's components with addition of uniform distributed loads for fabric roofing, side wall materials, and minor components. The uniform distribute fabric dead load is shown below for reference and use in the static computer model analysis.

Roof Fabric : $\text{AreaWt}_{\text{fabric}} = 18.0\text{-oz per sq yard}$

The structure is designed to support the loads shown in this calculations. It may, or may not, be capable of supporting additional collateral loads. The owner of the structure shall not hand, or otherwise affix, additional loads to this structure without a review by an engineer qualified to make said review. Additionally, prior to adding load to this structure, the owner shall get a written confirmation by the qualified engineer as to the magnitude and location of the load, or loads, being applied.

Live Load :

Live loads produced by the use and occupancy of the building are found on Table 1607.1. In the case of this structure, their are no additional live loads.

Roof Live Load :

Based on performance and function of this building style, no short duration of the roof live load is expected on the fabric roof of the structure. If repairs are needed, usually one worker with light scissor lift would be suffice.

Snow Load :

This tent structure is assumed to be erected on a temporary basis, in locations, and during seasons, where snow loading is not expected. No snow loading value has been applied in this analysis ($P_s = 0\text{psf}$).

If a snow event is expected or is likely to occur while the fabric is still in place, then measures should be provided to ensure snow removal or melting. Furthermore, the prescribed gradient of the roof fabric should be maintained to allow for smooth drainage and to prevent the potential for ponding of melt water.



Wind Loads
 Design Parameters

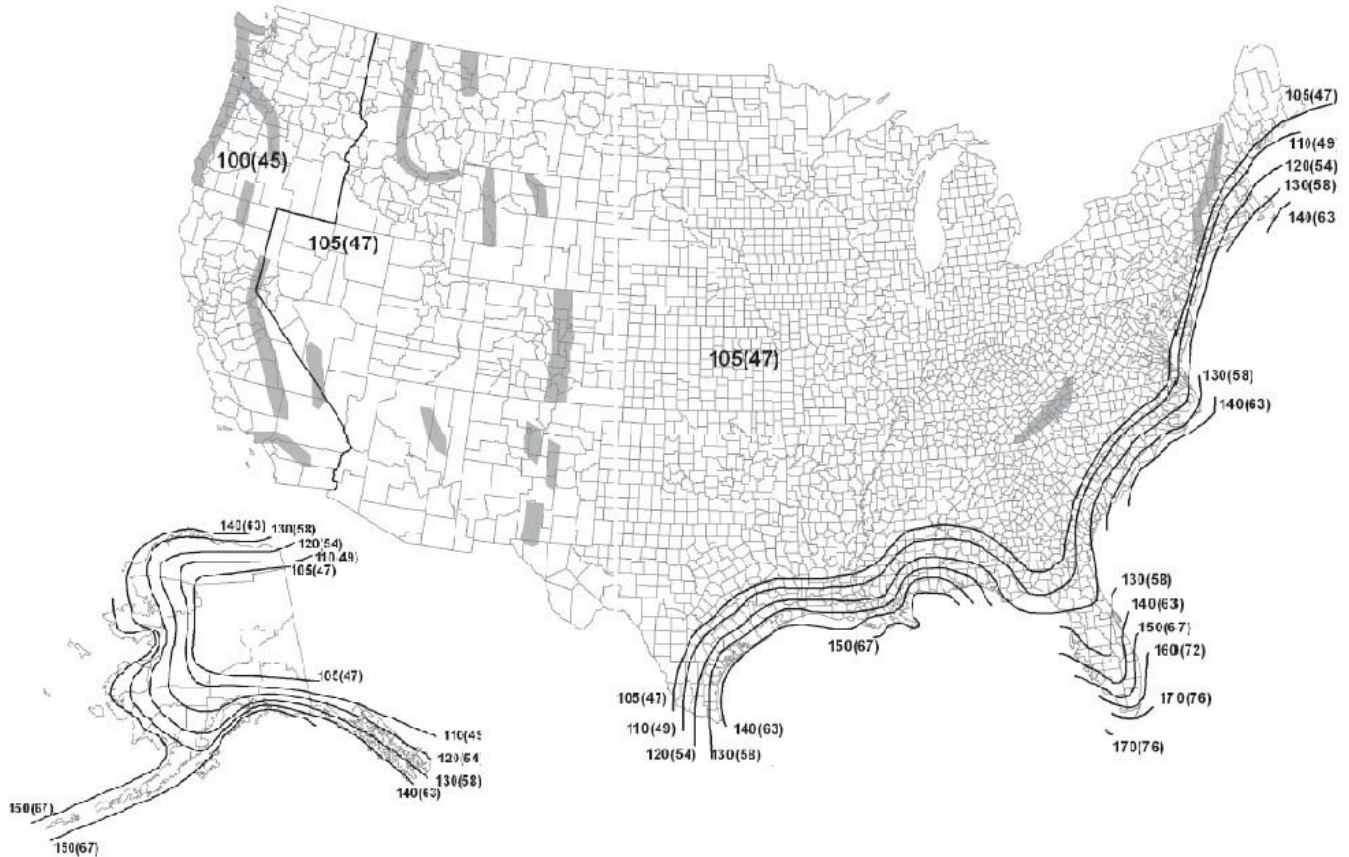

Risk Category:	Cat = "I"	[Table 1.5-1]
Occupancy of Building =	"Buildings and other structures that represent a low risk to human life in the event of failure"	
Basic Wind Speed:	V = 120 mph	[Section 26.5.1]
Mean Recurrence Interval:	MRI = 2 yr	[Section C26.5.1 & ASCE 7-05 Table C6-3]
Reduction Factor for 'Other' MRI:	R _n = 0.68	
Effective Wind Speed:	V _r = 81.34 mph	
Wind Directionality Factor:	K _d = 0.85	[Table 26.6-1]
Exposure Category:	Exposure = "B"	[Section 26.7]
Topographic Factor:	K _{zt} = 1	[Section 26.8.2]
Gust Effect Factor:	G = 0.85	[Section 26.9.1]

Per ASCE 7-10 Section 26.9.1 & 26.9.2, the gust-effect factor for Low-Rise Buildings as defined in Section 26.2, are permitted to be taken as 0.85.



Envelope Procedure for Low Rise Buildings - ASCE 7-10 Chapter 28

Per ASCE 7-10 Section 26.2, buildings with mean roof height h less than or equal to 60 ft, and with mean roof height h dose not exceed least horizontal dimension are considered as low-rise building.

Check Low Rise Criteria = "both low-rise conditions are satisfied"

Per ASCE 7-10 Section 28.1.4, no reduction to the velocity pressure is taken due to apparent shielding.

Velocity Pressure :

$q_z = 0.00256 \cdot K_z \cdot K_{zt} \cdot K_d \cdot V_r^2$	velocity pressure evaluated at peak height	[Section 28.3.2;
$q_h = 0.00256 \cdot K_h \cdot K_{zt} \cdot K_d \cdot V_r^2$	velocity pressure evaluated at mean roof height	Equation 28.3-1]

where :

for $15\text{ft} \leq z \leq z_g$

for $z \leq 15\text{ft}$

$$K_z = 2.01 \cdot \left(\frac{z}{z_g} \right)^{\frac{2}{\alpha}}$$

$$K_z = 2.01 \cdot \left(\frac{15\text{ft}}{z_g} \right)^{\frac{2}{\alpha}}$$

[Table 28.3-1]

*Note: z shall not be taken less than 30 feet in exposure B.

$z_g = 1200 \cdot \text{ft}$

[Table 26.9.1]

$K_z = 0.7$ velocity pressure exposure coefficient evaluated at peak height ($z = 12.5 \cdot \text{ft}$)

$K_h = 0.7$ velocity pressure exposure coefficient evaluated at mean roof height ($h = 9.61 \cdot \text{ft}$)

$q_z = 10.09 \cdot \text{psf}$ velocity pressure evaluated at building height, z

$q_h = 10.09 \cdot \text{psf}$ velocity pressure evaluated at mean roof height, h



Design Wind Pressure

$$p = q_h \cdot [(GC_{pf}) - (GC_{pi})]$$

[Equation 28.4-1]

External Pressure Coefficients (GC_{pf})

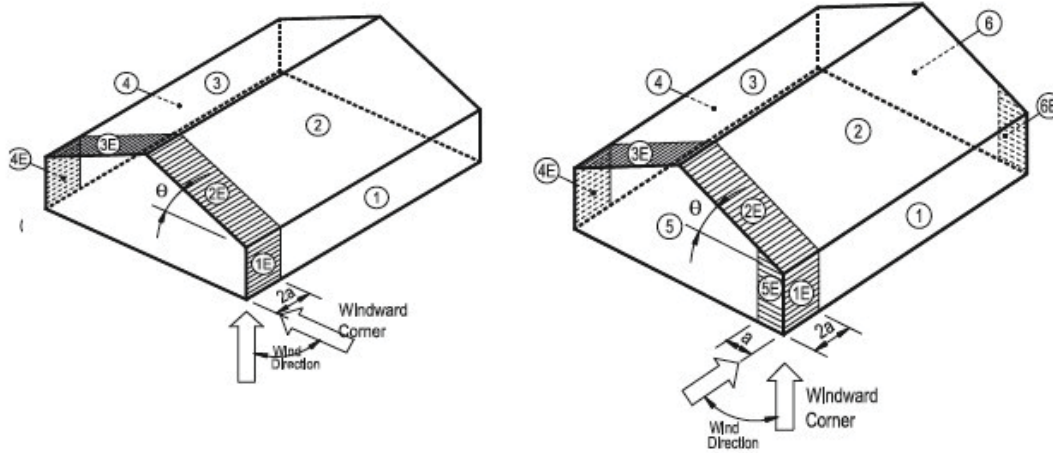

Load Case A
Load Case B
ASCE 7-10 FIGURE 28.4-1 External Pressure Coefficients (GC_{pf})

Transverse Direction (Load Case A)

$GC_{pf.A}$	"1"	"2"	"3"	"4"	"1E"	"2E"	"3E"	"4E"
	0.56	0.21	-0.43	-0.37	0.69	0.27	-0.53	-0.48

$a = 3 \cdot ft$
 $2 \cdot a = 6.00 \cdot ft$

(interpolated to the roof slope at: $\theta_{roof} = 30 \cdot deg$)

Longitudinal Direction (Load Case B)

$GC_{pf.B}$	"1"	"2"	"3"	"4"	"5"	"6"	"1E"	"2E"	"3E"	"4E"	"5E"	"6E"
	-0.45	-0.69	-0.37	-0.45	0.4	-0.29	-0.48	-1.07	-0.53	-0.48	0.61	-0.43

Application of Pressures on Building Surfaces 2 and 3

Per note 8 in ASCE 7-10 Fig. 28.4-1, the roof pressure coefficient (GC_{pf}), when negative in Zone 2 and 2E, shall be applied in Zone 2/2E for a distance from the edge of the roof equal to $0.5 \cdot$ horizontal dimension of the building parallel to the direction of the MWFRS being designed or $2.5 \cdot$ the eave height at the windward wall, whichever is less; the remainder of Zone 2/2E extending to the ridge line shall use the pressure coefficient (GC_{pf}) for Zone 3/3E.

Zone 2/2E Distance_{CaseA} = 10·ft

Zone 2/2E Distance_{CaseB} = 15·ft

Internal Pressure Coefficients (GC_{pi})

Enclosure Classification = "The building qualifies as an Enclosed Building (See ASCE 7-10 Section 26.2)"

GC_{pi}	"Overpressure"	0.18
	"Underpressure"	-0.18

[Table 26.11-1]



Wind at Transverse Direction (Load Case A)

$P_A =$	"1"	"2"	"3"	"4"	"1E"	"2E"	"3E"	"4E"	·psf
	3.83	0.30	-6.15	-5.55	5.14	0.91	-7.16	-6.66	
	7.46	3.93	-2.52	-1.92	8.77	4.54	-3.53	-3.03	

*top line = overpressure, bottom line = underpressure

Wind at Longitudinal Direction (Load Case B)

$P_B =$	"1"	"2"	"3"	"4"	"5"	"6"	"1E"	"2E"	"3E"	"4E"	"5E"	"6E"
	-6.35	-8.77	-5.55	-6.35	2.22	-4.74	-6.66	-12.61	-7.16	-6.66	4.34	-6.66
	-2.72	-5.14	-1.92	-2.72	5.85	-1.11	-3.03	-8.98	-3.53	-3.03	7.97	-2.72

*top line = overpressure, bottom line = underpressure

Design Wind Pressure on Gable

$p_g =$	"5"	"6"	"5E"	"6E"	·psf
	2.22	-4.74	4.34	-6.15	
	5.85	-1.11	7.97	-2.52	

Minimum Design Wind Loads

Per ASCE 7-10 Section 28.4.4, the wind load to be used in the design of the MWFRS for an enclosed or partially enclosed building shall not be less than 16 psf multiplied by the wall area of the building and 8 psf multiplied by the roof area of the building projected onto a vertical plane normal to the assumed wind direction.

Minimum Wall Pressure = 6.67·pli

Minimum Roof Pressure = 3.33·pli

Design Wind Loads

The wind pressure on one bay must be supported by one arch. The total wind load per arch equals :

$$WL = p \cdot L_{bay} \quad L_{bay} = 10 \cdot \text{ft}$$

Wind at Transverse Direction (Load Case A)

$W_{L_A} =$	"1"	"2"	"3"	"4"	"1E"	"2E"	"3E"	"4E"	·pli
	3.19	0.25	-5.13	-4.62	4.29	0.76	-5.97	-5.55	
	6.22	3.28	-2.1	-1.6	7.31	3.78	-2.94	-2.52	

top line = overpressure, bottom line = underpressure

Wind at Longitudinal Direction (Load Case B)

$W_{L_B} =$	"1"	"2"	"3"	"4"	"5"	"6"	"1E"	"2E"	"3E"	"4E"	"5E"	"6E"
	-5.29	-7.31	-4.62	-5.29	1.85	-3.95	-5.55	-10.51	-5.97	-5.55	3.61	-5.13
	-2.27	-4.29	-1.6	-2.27	4.87	-0.92	-2.52	-7.48	-2.94	-2.52	6.64	-2.1

top line = overpressure, bottom line = underpressure



Design Wind Loads for First Arch from End

WL _{A1} =	"1E"	"2E"	"3E"	"4E"	·pli	
	2.14	0.38	-2.98	-2.77		
	3.66	1.89	-1.47	-1.26		

WL _{B1} =	"1E"	"2E"	"3E"	"4E"	"5E"	"6E"	·pli
	-2.77	-5.25	-2.98	-2.77	1.81	-2.56	
	-1.26	-3.74	-1.47	-1.26	3.32	-1.05	

Design Wind Loads for Second Arch from End

WL _{A2} =	"1/1E"	"2/2E"	"3/3E"	"4/4E"	·pli	
	3.3	0.3	-5.21	-4.71		
	6.33	3.33	-2.19	-1.69		

WL _{B2} =	"1E"	"2E"	"3E"	"4E"	"5E"	"6E"	·pli
	-5.32	-7.63	-4.76	-5.32	2.03	-4.07	
	-2.29	-4.61	-1.73	-2.29	5.05	-1.04	

Design Wind Loads for All Other Arches

WL _{A3} =	"1"	"2"	"3"	"4"	·pli	
	3.19	0.25	-5.13	-4.62		
	6.22	3.28	-2.1	-1.6		

WL _{B3} =	"1"	"2"	"3"	"4"	"5"	"6"	·pli
	-5.29	-7.31	-4.62	-5.29	1.85	-3.95	
	-2.27	-4.29	-1.6	-2.27	4.87	-0.92	

* top line = overpressure
 bottom line = underpressure

Torsional Load Cases

Per note 5 in ASCE 7-10 Figure 28.4-1, one story buildings with h less than or equal to 30 ft, buildings two stories or less framed with light frame construction, and buildings two stories or less designed with flexible diaphragms need not be designed for the torsional cases.

Check Torsional Load Case = "Torsional load cases need not to be designed"



4. LRFD Load Combinations :

ASCE Section 2.2 : SYMBOLS AND NOTATION

- D = dead load
- D_i = weight of ice
- E = earthquake load
- F = load due to fluids with well-defined pressures and maximum heights
- F_a = flood load
- H = load due to lateral earth pressure, ground water pressure, or pressure of bulk materials
- L = live load
- L_r = roof live load
- R = rain load
- S = snow load
- T = self-straining force
- W = wind load
- W_i = wind-on-ice determined in accordance with Chapter 10

ASCE Section 2.3 : COMBINING FACTORED LOADS USING STRENGTH DESIGN

Section 2.3.2 : Basic Combinations. Structures, components, and foundations shall be designed so that their design strength equals or exceeds the effects of the factored loads in the following combinations:

1. $1.4D$
2. $1.2D + 1.6L + 0.5(L_r \text{ or } S \text{ or } R)$
3. $1.2D + 1.6(L_r \text{ or } S \text{ or } R) + (L \text{ or } 0.5W)$
4. $1.2D + 1.0W + L + 0.5(L_r \text{ or } S \text{ or } R)$
5. $1.2D + 1.0E + L + 0.2S$
6. $0.9D + 1.0W$
7. $0.9D + 1.0E$



TopTec Events Tents
7601 Highway 221
Moore, SC. 29369
(800) 845-2830
(864) 804-5901
www.toptecproducts.com

Symbols as Used in Calculations

D_1 = dead load;	W_1 = wind load perpendicular to long side and with internal underpressure
D_2 = not used;	W_2 = wind load perpendicular to long side and with internal overpressure
L_r = not used;	W_3 = wind load perpendicular to short side and with internal underpressure
S_1 = not used;	W_4 = wind load perpendicular to short side and with internal overpressure
S_2 = not used;	

* "- roof pressure" = wind pressure acting away from roof

"+ roof pressure" = wind pressure acting toward to roof

Combinations as Applied in Calculations :

$$1.01 - 1.4D_1$$

$$6.01 - 0.9D_1 + 1.0W_1$$

$$6.02 - 0.9D_1 + 1.0W_2$$

$$6.03 - 0.9D_1 + 1.0W_3$$

$$6.04 - 0.9D_1 + 1.0W_4$$



5a. Beam Pipe Design

Section Properties:

$E = 10100 \cdot \text{ksi}$	Table 3.3-1
$n_u = 1.95$	Table 3.4-1
<u>main extrusion</u>	
$A_g = 0.368 \cdot \text{in}^2$	Cross-Sectional area of shape
$I = 0.17 \cdot \text{in}^4$	Moment of inertia
$S = 0.17 \cdot \text{in}^3$	Section modulus
$r = 0.69 \cdot \text{in}$	Radius of gyration
$K = 1.0$	Factor for buckling
$L = 126 \cdot \text{in}$	Length for buckling

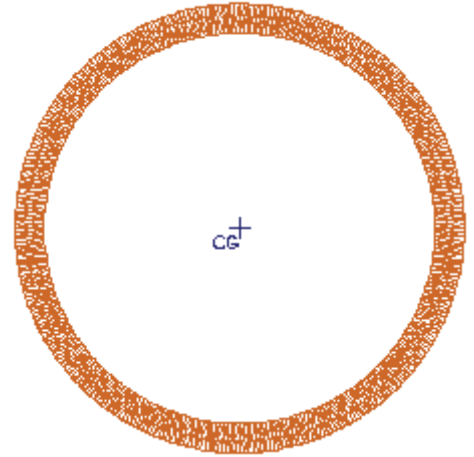

Allowable Axial Stress:

The following allowable stresses are based on values from the "2005 Aluminum Design Manual"

<u>Specification 3.4.1 - Tension, axial:</u> Any tension member.	$F_{3.4.1} = 32.3 \cdot \text{ksi}$	$F_{3.4.1} = 222.7 \cdot \text{MPa}$	
<u>Specification 3.4.7 - Compression in Columns:</u> All columns.	$F_{3.4.7x} = 2.81 \cdot \text{ksi}$	$F_{3.4.7x} = 19.4 \cdot \text{MPa}$	
	$F_{3.4.7y} = 2.81 \cdot \text{ksi}$	$F_{3.4.7y} = 19.4 \cdot \text{MPa}$	
<u>Specification 3.4.10 - Compression in Column Elements:</u> Curved elements supported on both edges.	$F_{3.4.10} = 31.33 \cdot \text{ksi}$	$F_{3.4.10} = 216 \cdot \text{MPa}$	
<u>Allowable Axial Stress:</u>	Use in Eq. 4.1.1-1	$F_a = 2.81 \cdot \text{ksi}$	$F_a = 19.4 \cdot \text{MPa}$
	Use in Eq. 4.1.1-2	$F_{ao} = 31.33 \cdot \text{ksi}$	$F_{ao} = 216 \cdot \text{MPa}$
		$F_{ex} = 2.81 \cdot \text{ksi}$	$F_{ex} = 19.4 \cdot \text{MPa}$
		$F_{ey} = 2.81 \cdot \text{ksi}$	$F_{ey} = 19.4 \cdot \text{MPa}$



Allowable Bending Stress:

<u>Specification 3.4.2 - Tension in Beams, extreme fibre, net section:</u> Flat elements in uniform tension (flanges).	$F_{3.4.2} = 32.3 \cdot \text{ksi}$	$F_{3.4.2} = 222.7 \cdot \text{MPa}$
<u>Specification 3.4.14 - Compression in Beams, gross section:</u> Tubular shapes.	$F_{3.4.14} = 29 \cdot \text{ksi}$	$F_{3.4.14} = 199.9 \cdot \text{MPa}$
<u>Specification 3.4.16.1 - Compression in Beams, gross section:</u> Curved elements supported on both edges.	$F_{3.4.16.1} = 31.33 \cdot \text{ksi}$	$F_{3.4.16.1} = 216 \cdot \text{MPa}$
<u>Allowable Bending Stress:</u>	Use in Eq. 4.1.1-1 & Eq. 4.1.1-2	
	$F_{bx} = 31.33 \cdot \text{ksi}$	$F_{bx} = 216 \cdot \text{MPa}$
	$F_{by} = 31.33 \cdot \text{ksi}$	$F_{by} = 216 \cdot \text{MPa}$

Actual Stress :

Member ID = "R101"	$M_x = -2.77 \cdot \text{kip} \cdot \text{in}$	$M_y = 0 \cdot \text{kip} \cdot \text{in}$	$C = -0.01 \cdot \text{kip}$
Load Case = "0.9D1 + 1.0W4"	$f_{bx} := \left \frac{M_x}{S_x} \right $	$f_{by} := \left \frac{M_y}{S_y} \right $	$f_{ac} := \left \frac{C}{A_g} \right $
$C_{mx} := 0.85$ $C_{my} := 0.85$	$f_{bx} = 16 \cdot \text{ksi}$	$f_{by} = 0.0 \cdot \text{ksi}$	$f_{ac} = 0.0 \cdot \text{ksi}$

Eq. 4.1.1-1 :
$$\text{Eq1} := \frac{f_{ac}}{F_a} + \frac{C_{mx} \cdot f_{bx}}{\left(1 - \frac{f_{ac}}{F_{ex}}\right) \cdot F_{bx}} + \frac{C_{my} \cdot f_{by}}{\left(1 - \frac{f_{ac}}{F_{ey}}\right) \cdot F_{by}}$$
 $\text{Eq1} = 0.44$
 Eq1 is less than or equal to 1.0 = "OK"

Eq. 4.1.1-2 :
$$\text{Eq2} := \frac{f_{ac}}{F_{ao}} + \frac{f_{bx}}{F_{bx}} + \frac{f_{by}}{F_{by}}$$
 $\text{Eq2} = 0.51$
 Eq2 is less than or equal to 1.0 = "OK"

Member ID = "M105"	$M_x = -0.47 \cdot \text{kip} \cdot \text{in}$	$M_y = 3.97 \cdot \text{kip} \cdot \text{in}$	$T = 0.05 \cdot \text{kip}$
Load Case = "0.9D1 + 1.0W4"	$f_{bx} := \left \frac{M_x}{S_x} \right $	$f_{by} := \left \frac{M_y}{S_y} \right $	$f_{at} := \left \frac{T}{A_g} \right $
	$f_{bx} = 2.7 \cdot \text{ksi}$	$f_{by} = 22.9 \cdot \text{ksi}$	$f_{at} = 0.1 \cdot \text{ksi}$

Eq. 4.1.2-1 :
$$\text{Eq3} := \frac{f_{at}}{F_{3.4.1}} + \frac{f_{bx}}{F_{bx}} + \frac{f_{by}}{F_{by}}$$
 $\text{Eq3} = 0.82$
 Eq3 is less than or equal to 1.0 = "OK"



5b. Post Profile Design

Section Properties:

$E = 10100 \cdot \text{ksi}$	Table 3.3-1
$n_u = 1.95$	Table 3.4-1
<u>main extrusion</u>	
$A_g = 0.368 \cdot \text{in}^2$	Cross-Sectional area of shape
$I = 0.17 \cdot \text{in}^4$	Moment of Inertia
$S = 0.17 \cdot \text{in}^3$	Section Modulus
$r = 0.69 \cdot \text{in}$	Radius of Gyration
$K = 1.0$	Factor for buckling
$L = 68.71 \cdot \text{in}$	Length for buckling

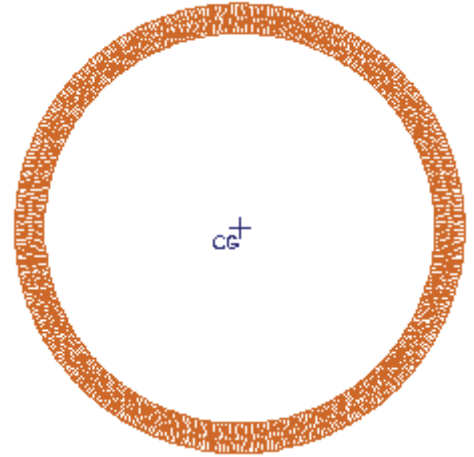

Allowable Axial Stress:

The following allowable stresses are based on values from the "2005 Aluminum Design Manual"

<u>Specification 3.4.1 - Tension, axial:</u> Any tension member.	$F_{3.4.1} = 32.3 \cdot \text{ksi}$	$F_{3.4.1} = 222.7 \cdot \text{MPa}$	
<u>Specification 3.4.7 - Compression in Columns:</u> All columns.	$F_{3.4.7x} = 8.37 \cdot \text{ksi}$	$F_{3.4.7x} = 57.7 \cdot \text{MPa}$	
	$F_{3.4.7y} = 8.37 \cdot \text{ksi}$	$F_{3.4.7y} = 57.7 \cdot \text{MPa}$	
<u>Specification 3.4.10 - Compression in Column Elements:</u> Curved elements supported on both edges.	$F_{3.4.10} = 31.33 \cdot \text{ksi}$	$F_{3.4.10} = 216 \cdot \text{MPa}$	
<u>Allowable Axial Stress:</u>	Use in Eq. 4.1.1-1	$F_a = 8.37 \cdot \text{ksi}$	$F_a = 57.7 \cdot \text{MPa}$
	Use in Eq. 4.1.1-2	$F_{ao} = 31.33 \cdot \text{ksi}$	$F_{ao} = 216 \cdot \text{MPa}$
		$F_{ex} = 8.37 \cdot \text{ksi}$	$F_{ex} = 57.7 \cdot \text{MPa}$
		$F_{ey} = 8.37 \cdot \text{ksi}$	$F_{ey} = 57.7 \cdot \text{MPa}$



Allowable Bending Stress:

<u>Specification 3.4.2 - Tension in Beams, extreme fibre, net section:</u> Flat elements in uniform tension (flanges).	$F_{3.4.2} = 32.3 \cdot \text{ksi}$	$F_{3.4.2} = 222.7 \cdot \text{MPa}$
<u>Specification 3.4.14 - Compression in Beams, gross section.:</u> Tubular shapes.	$F_{3.4.14} = 30.17 \cdot \text{ksi}$	$F_{3.4.14} = 208 \cdot \text{MPa}$
<u>Specification 3.4.16.1 - Compression in Beams, gross section:</u> Curved elements supported on both edges.	$F_{3.4.16.1} = 31.33 \cdot \text{ksi}$	$F_{3.4.16.1} = 216 \cdot \text{MPa}$
<u>Allowable Bending Stress:</u>	Use in Eq. 4.1.1-1 & Eq. 4.1.1-2	
	$F_{bx} = 31.33 \cdot \text{ksi}$	$F_{bx} = 216 \cdot \text{MPa}$
	$F_{by} = 31.33 \cdot \text{ksi}$	$F_{by} = 216 \cdot \text{MPa}$

Actual Stress (Leg Post):

Member ID = "C107"	$M_x = -3.15 \cdot \text{kip} \cdot \text{in}$	$M_y = 0.06 \cdot \text{kip} \cdot \text{in}$	$C = -0.82 \cdot \text{kip}$
Load Case = "0.9D1 + 1.0W2"	$f_{bx} := \left \frac{M_x}{S_x} \right $	$f_{by} := \left \frac{M_y}{S_y} \right $	$f_{ac} := \left \frac{C}{A_g} \right $
$C_{mx} := 0.85$ $C_{my} := 0.85$	$f_{bx} = 18.1 \cdot \text{ksi}$	$f_{by} = 0.3 \cdot \text{ksi}$	$f_{ac} = 2.2 \cdot \text{ksi}$
	$f_{bx} = 125.1 \cdot \text{MPa}$	$f_{by} = 2.3 \cdot \text{MPa}$	$f_{ac} = 15.3 \cdot \text{MPa}$

Eq. 4.1.1-1 :
$$\text{Eq1} := \frac{f_{ac}}{F_a} + \frac{C_{mx} \cdot f_{bx}}{\left(1 - \frac{f_{ac}}{F_{ex}}\right) \cdot F_{bx}} + \frac{C_{my} \cdot f_{by}}{\left(1 - \frac{f_{ac}}{F_{ey}}\right) \cdot F_{by}}$$
 $\text{Eq1} = 0.95$
 Eq1 is less than or equal to 1.0 = "OK"

Eq. 4.1.1-2 :
$$\text{Eq2} := \frac{f_{ac}}{F_{ao}} + \frac{f_{bx}}{F_{bx}} + \frac{f_{by}}{F_{by}}$$
 $\text{Eq2} = 0.66$
 Eq2 is less than or equal to 1.0 = "OK"

Member ID = "C103"	$M_x = -0.11 \cdot \text{kip} \cdot \text{in}$	$M_y = -0.17 \cdot \text{kip} \cdot \text{in}$	$T = 0.36 \cdot \text{kip}$
Load Case = "0.9D1 + 1.0W4"	$f_{bx} := \left \frac{M_x}{S_x} \right $	$f_{by} := \left \frac{M_y}{S_y} \right $	$f_{at} := \left \frac{T}{A_g} \right $
	$f_{bx} = 0.6 \cdot \text{ksi}$	$f_{by} = 1 \cdot \text{ksi}$	$f_{at} = 1 \cdot \text{ksi}$

Eq. 4.1.2-1 :
$$\text{Eq3} := \frac{f_{at}}{F_{3.4.1}} + \frac{f_{bx}}{F_{bx}} + \frac{f_{by}}{F_{by}}$$
 $\text{Eq3} = 0.08$
 Eq3 is less than or equal to 1.0 = "OK"



6. Guy Strap Assembly Check

- The 1" x 12' guy strap assemblies consist of a ratchet strap with sewn eye on the fixed end and a flat snap hook on the adjustable end. Breaking strength of the assembly is 3,000 lbf.

Breaking Strength of Assembly : Breaking Strength = 3000·lbf

Recommended Safety Factor is : Safety Factor = 2

Available Strength of Assembly: Working Strength = 1500·lbf

Tensile force of guy strap assembly placed at 45 deg (measure from vertical post): $T_{45} = 680.03 \cdot \text{lbf}$
 T_{45} is less than or equal to Working Strength = "OK"

Tensile force of guy strap assembly placed at 30 deg (measure from vertical post): $T_{30} = 961.71 \cdot \text{lbf}$
 T_{30} is less than or equal to Working Strength = "OK"

Tensile force of guy strap assembly placed at 15 deg (measure from vertical post): $T_{15} = 1857.89 \cdot \text{lbf}$
 T_{15} is less than or equal to Working Strength = "NOT OK"

Guy cable reactions summary:

Express Tents - Guy Cables		
Degree	Vertical - uplift	Horizontal
45	481 lb	481 lb
30	833 lb	481 lb
15	not permitted	not permitted



TopTec Events Tents
7601 Highway 221
Moore, SC. 29369
(800) 845-2830
(864) 804-5901

This page intentionally left blank



TopTec Events Tents
7601 Highway 221
Moore, SC. 29369
(800) 845-2830
(864) 804-5901
www.toptecproducts.com

APPENDIX A

COMPUTER MODEL INPUT





TopTec Events Tents
7601 Highway 221
Moore, SC. 29369
(800) 845-2830
(864) 804-5901
www.toptecproducts.com

This page intentionally left blank

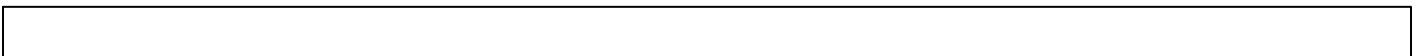

Project: Express Structure

Table of Contents

Table of Contents
Model Summary
Nodes
Nodal Supports
Material Properties
Service Load Cases
Load Cases

Model Summary

Structure Type: Space Frame
32 Nodes, and 132 Degrees of Freedom
41 Member Elements
The model is non-linear.
The size of the model is:
360 in, in the X direction
120 in, in the Y direction
480 in, in the Z direction

Nodes

Node	X in	Y in	Z in	Fix DX	Fix DY	Fix DZ	Fix RX	Fix RY	Fix RZ
B100	-120.000	0.000	0.000	Yes	Yes	Yes	No	No	No
B101	0.000	0.000	0.000	Yes	Yes	Yes	No	No	No
B102	120.000	0.000	0.000	Yes	Yes	Yes	No	No	No
B103	-120.000	0.000	120.000	Yes	Yes	Yes	No	No	No
B104	120.000	0.000	120.000	Yes	Yes	Yes	No	No	No
B107	-120.000	0.000	240.000	Yes	Yes	Yes	No	No	No
B108	120.000	0.000	240.000	Yes	Yes	Yes	No	No	No
B109	-120.000	0.000	360.000	Yes	Yes	Yes	No	No	No
B110	0.000	0.000	360.000	Yes	Yes	Yes	No	No	No
B111	120.000	0.000	360.000	Yes	Yes	Yes	No	No	No
G100	-180.000	0.000	-60.000	Yes	Yes	Yes	No	No	No
G101	0.000	0.000	-60.000	Yes	Yes	Yes	No	No	No
G102	180.000	0.000	-60.000	Yes	Yes	Yes	No	No	No
G103	-180.000	0.000	120.000	Yes	Yes	Yes	No	No	No
G104	180.000	0.000	120.000	Yes	Yes	Yes	No	No	No
G107	-180.000	0.000	240.000	Yes	Yes	Yes	No	No	No
G108	180.000	0.000	240.000	Yes	Yes	Yes	No	No	No
G109	-180.000	0.000	420.000	Yes	Yes	Yes	No	No	No
G110	0.000	0.000	420.000	Yes	Yes	Yes	No	No	No
G111	180.000	0.000	420.000	Yes	Yes	Yes	No	No	No
N100	-120.000	80.712	0.000	No	No	No	No	No	No
N105	0.000	80.712	0.000	No	No	No	No	No	No
N204	0.000	80.712	360.000	No	No	No	No	No	No
N209	120.000	80.712	360.000	No	No	No	No	No	No
N304	-120.000	80.712	120.000	No	No	No	No	No	No
N314	-120.000	80.712	240.000	No	No	No	No	No	No
N319	-120.000	80.712	360.000	No	No	No	No	No	No
N400	120.000	80.712	0.000	No	No	No	No	No	No
N405	120.000	80.712	120.000	No	No	No	No	No	No
N415	120.000	80.712	240.000	No	No	No	No	No	No
P100	-0.000	120.00 0	120.000	No	No	No	No	No	No
P102	0.000	120.00 0	240.000	No	No	No	No	No	No

Nodal Supports

Node	Fix DX	Fix DY	Fix DZ	Fix RX	Fix RY	Fix RZ
B100	Yes	Yes	Yes	No	No	No

Project: Express Structure

B101	Yes	Yes	Yes	No	No	No
B102	Yes	Yes	Yes	No	No	No
B103	Yes	Yes	Yes	No	No	No
B104	Yes	Yes	Yes	No	No	No
B107	Yes	Yes	Yes	No	No	No
B108	Yes	Yes	Yes	No	No	No
B109	Yes	Yes	Yes	No	No	No
B110	Yes	Yes	Yes	No	No	No
B111	Yes	Yes	Yes	No	No	No
G100	Yes	Yes	Yes	No	No	No
G101	Yes	Yes	Yes	No	No	No
G102	Yes	Yes	Yes	No	No	No
G103	Yes	Yes	Yes	No	No	No
G104	Yes	Yes	Yes	No	No	No
G107	Yes	Yes	Yes	No	No	No
G108	Yes	Yes	Yes	No	No	No
G109	Yes	Yes	Yes	No	No	No
G110	Yes	Yes	Yes	No	No	No
G111	Yes	Yes	Yes	No	No	No

Material Properties

Material	Strength psi	Elasticity psi	Poisson	Density lb/in ³	Therm. Coeff. in/in/deg-F
6061-T6-E	35000.000	10100000.000	0.330000	0.098	1.310e-005
Weightless Steel (Fy = 50ksi)	50000.000	29000000.000	0.290000	0.000	6.389e-006

Service Load Cases

Load Case	Self Weight
D	Standard
W1	None
W2	None
W3	None
W4	None

Load Cases

Load Case
(1)D
(2)W1
(3)W2
(4)W3
(5)W4
(6)0.9D1 + 1.0W1
(7)0.9D1 + 1.0W2
(8)0.9D1 + 1.0W3
(9)0.9D1 + 1.0W4



TopTec Events Tents
7601 Highway 221
Moore, SC. 29369
(800) 845-2830
(864) 804-5901
www.toptecproducts.com

APPENDIX B

COMPUTER MODEL OUTPUT

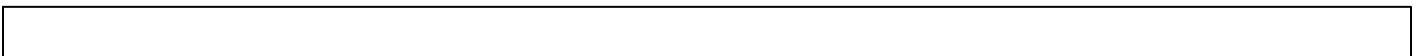



TopTec Events Tents
7601 Highway 221
Moore, SC. 29369
(800) 845-2830
(864) 804-5901
www.toptecproducts.com

This page intentionally left blank



Project: Express Structure

B101	D	0	12	1	-NA-	-NA-	-NA-
B101	W1	-0	-77	215	-NA-	-NA-	-NA-
B101	W2	-1	-39	93	-NA-	-NA-	-NA-
B101	W3	0	504	-23	-NA-	-NA-	-NA-
B101	W4	0	783	-37	-NA-	-NA-	-NA-
B102	0.9D1 + 1.0W1	-28	13	31	-NA-	-NA-	-NA-
B102	0.9D1 + 1.0W2	-35	79	46	-NA-	-NA-	-NA-
B102	0.9D1 + 1.0W3	-109	161	-11	-NA-	-NA-	-NA-
B102	0.9D1 + 1.0W4	-58	403	-18	-NA-	-NA-	-NA-
B102	D	-1	18	1	-NA-	-NA-	-NA-
B102	W1	-96	-12	107	-NA-	-NA-	-NA-
B102	W2	-34	63	45	-NA-	-NA-	-NA-
B102	W3	-109	152	-11	-NA-	-NA-	-NA-
B102	W4	-58	380	-19	-NA-	-NA-	-NA-
B103	0.9D1 + 1.0W1	-10	190	0	-NA-	-NA-	-NA-
B103	0.9D1 + 1.0W2	-47	823	-1	-NA-	-NA-	-NA-
B103	0.9D1 + 1.0W3	214	-319	0	-NA-	-NA-	-NA-
B103	0.9D1 + 1.0W4	94	-357	-2	-NA-	-NA-	-NA-
B103	D	0	11	0	-NA-	-NA-	-NA-
B103	W1	-36	652	-0	-NA-	-NA-	-NA-
B103	W2	-47	818	-1	-NA-	-NA-	-NA-
B103	W3	214	-318	0	-NA-	-NA-	-NA-
B103	W4	94	-367	-2	-NA-	-NA-	-NA-
B104	0.9D1 + 1.0W1	-55	-116	-0	-NA-	-NA-	-NA-
B104	0.9D1 + 1.0W2	-66	-184	0	-NA-	-NA-	-NA-
B104	0.9D1 + 1.0W3	-429	-34	-0	-NA-	-NA-	-NA-
B104	0.9D1 + 1.0W4	-94	-103	-2	-NA-	-NA-	-NA-
B104	D	-0	11	-0	-NA-	-NA-	-NA-
B104	W1	-191	-442	0	-NA-	-NA-	-NA-
B104	W2	-66	-194	0	-NA-	-NA-	-NA-
B104	W3	-428	-33	-0	-NA-	-NA-	-NA-
B104	W4	-93	-99	-2	-NA-	-NA-	-NA-
B107	0.9D1 + 1.0W1	-10	190	0	-NA-	-NA-	-NA-
B107	0.9D1 + 1.0W2	-47	823	1	-NA-	-NA-	-NA-
B107	0.9D1 + 1.0W3	214	-298	-0	-NA-	-NA-	-NA-
B107	0.9D1 + 1.0W4	92	-116	0	-NA-	-NA-	-NA-
B107	D	0	11	0	-NA-	-NA-	-NA-
B107	W1	-36	652	0	-NA-	-NA-	-NA-
B107	W2	-47	818	1	-NA-	-NA-	-NA-
B107	W3	214	-296	-0	-NA-	-NA-	-NA-
B107	W4	92	-118	-0	-NA-	-NA-	-NA-
B108	0.9D1 + 1.0W1	-55	-116	0	-NA-	-NA-	-NA-
B108	0.9D1 + 1.0W2	-66	-184	-0	-NA-	-NA-	-NA-
B108	0.9D1 + 1.0W3	-429	9	-0	-NA-	-NA-	-NA-
B108	0.9D1 + 1.0W4	-92	219	0	-NA-	-NA-	-NA-
B108	D	-0	11	0	-NA-	-NA-	-NA-
B108	W1	-191	-442	-0	-NA-	-NA-	-NA-
B108	W2	-66	-194	-0	-NA-	-NA-	-NA-
B108	W3	-428	9	-0	-NA-	-NA-	-NA-
B108	W4	-92	217	-0	-NA-	-NA-	-NA-
B109	0.9D1 + 1.0W1	-5	130	-31	-NA-	-NA-	-NA-
B109	0.9D1 + 1.0W2	-34	535	-50	-NA-	-NA-	-NA-
B109	0.9D1 + 1.0W3	108	-103	-82	-NA-	-NA-	-NA-
B109	0.9D1 + 1.0W4	47	-39	-22	-NA-	-NA-	-NA-
B109	D	1	18	-1	-NA-	-NA-	-NA-
B109	W1	-20	379	-108	-NA-	-NA-	-NA-
B109	W2	-35	514	-49	-NA-	-NA-	-NA-
B109	W3	107	-115	-82	-NA-	-NA-	-NA-
B109	W4	46	-54	-21	-NA-	-NA-	-NA-
B110	0.9D1 + 1.0W1	-0	-11	-62	-NA-	-NA-	-NA-
B110	0.9D1 + 1.0W2	-1	-28	-94	-NA-	-NA-	-NA-

Project: Express Structure

B110	0.9D1 + 1.0W3	0	84	-164	-NA-	-NA-	-NA-
B110	0.9D1 + 1.0W4	0	-1	-43	-NA-	-NA-	-NA-
B110	D	0	12	-1	-NA-	-NA-	-NA-
B110	W1	-0	-77	-215	-NA-	-NA-	-NA-
B110	W2	-1	-39	-93	-NA-	-NA-	-NA-
B110	W3	0	83	-163	-NA-	-NA-	-NA-
B110	W4	0	-12	-42	-NA-	-NA-	-NA-
B111	0.9D1 + 1.0W1	-28	13	-31	-NA-	-NA-	-NA-
B111	0.9D1 + 1.0W2	-35	79	-46	-NA-	-NA-	-NA-
B111	0.9D1 + 1.0W3	-108	-76	-82	-NA-	-NA-	-NA-
B111	0.9D1 + 1.0W4	-47	-40	-22	-NA-	-NA-	-NA-
B111	D	-1	18	-1	-NA-	-NA-	-NA-
B111	W1	-96	-12	-107	-NA-	-NA-	-NA-
B111	W2	-34	63	-45	-NA-	-NA-	-NA-
B111	W3	-107	-85	-82	-NA-	-NA-	-NA-
B111	W4	-46	-54	-21	-NA-	-NA-	-NA-
G100	0.9D1 + 1.0W1	-96	-129	-96	-NA-	-NA-	-NA-
G100	0.9D1 + 1.0W2	-374	-503	-374	-NA-	-NA-	-NA-
G100	0.9D1 + 1.0W3	-153	-206	-153	-NA-	-NA-	-NA-
G100	0.9D1 + 1.0W4	-202	-272	-202	-NA-	-NA-	-NA-
G100	D	0	0	0	-NA-	-NA-	-NA-
G100	W1	-318	-428	-318	-NA-	-NA-	-NA-
G100	W2	-369	-496	-369	-NA-	-NA-	-NA-
G100	W3	-155	-209	-155	-NA-	-NA-	-NA-
G100	W4	-207	-279	-207	-NA-	-NA-	-NA-
G101	0.9D1 + 1.0W1	0	0	0	-NA-	-NA-	-NA-
G101	0.9D1 + 1.0W2	0	0	0	-NA-	-NA-	-NA-
G101	0.9D1 + 1.0W3	-0	-566	-421	-NA-	-NA-	-NA-
G101	0.9D1 + 1.0W4	-0	-606	-450	-NA-	-NA-	-NA-
G101	D	0	0	0	-NA-	-NA-	-NA-
G101	W1	0	0	0	-NA-	-NA-	-NA-
G101	W2	0	0	0	-NA-	-NA-	-NA-
G101	W3	-0	-575	-428	-NA-	-NA-	-NA-
G101	W4	-0	-611	-454	-NA-	-NA-	-NA-
G102	0.9D1 + 1.0W1	0	0	0	-NA-	-NA-	-NA-
G102	0.9D1 + 1.0W2	0	0	0	-NA-	-NA-	-NA-
G102	0.9D1 + 1.0W3	203	-273	-203	-NA-	-NA-	-NA-
G102	0.9D1 + 1.0W4	282	-380	-282	-NA-	-NA-	-NA-
G102	D	0	0	0	-NA-	-NA-	-NA-
G102	W1	0	0	0	-NA-	-NA-	-NA-
G102	W2	0	0	0	-NA-	-NA-	-NA-
G102	W3	205	-276	-205	-NA-	-NA-	-NA-
G102	W4	273	-368	-273	-NA-	-NA-	-NA-
G103	0.9D1 + 1.0W1	-150	-201	-0	-NA-	-NA-	-NA-
G103	0.9D1 + 1.0W2	-481	-647	-0	-NA-	-NA-	-NA-
G103	0.9D1 + 1.0W3	-239	-402	0	-NA-	-NA-	-NA-
G103	0.9D1 + 1.0W4	0	0	0	-NA-	-NA-	-NA-
G103	D	0	0	0	-NA-	-NA-	-NA-
G103	W1	-543	-730	-0	-NA-	-NA-	-NA-
G103	W2	-486	-654	-0	-NA-	-NA-	-NA-
G103	W3	-309	-415	0	-NA-	-NA-	-NA-
G103	W4	0	0	0	-NA-	-NA-	-NA-
G104	0.9D1 + 1.0W1	0	0	0	-NA-	-NA-	-NA-
G104	0.9D1 + 1.0W2	0	0	0	-NA-	-NA-	-NA-
G104	0.9D1 + 1.0W3	372	-501	0	-NA-	-NA-	-NA-
G104	0.9D1 + 1.0W4	44	-59	0	-NA-	-NA-	-NA-
G104	D	0	0	0	-NA-	-NA-	-NA-
G104	W1	0	0	0	-NA-	-NA-	-NA-
G104	W2	0	0	0	-NA-	-NA-	-NA-
G104	W3	383	-515	0	-NA-	-NA-	-NA-
G104	W4	58	-78	0	-NA-	-NA-	-NA-

Project: Express Structure

G107	0.9D1 + 1.0W1	-150	-201	0	-NA-	-NA-	-NA-
G107	0.9D1 + 1.0W2	-481	-647	0	-NA-	-NA-	-NA-
G107	0.9D1 + 1.0W3	-315	-424	0	-NA-	-NA-	-NA-
G107	0.9D1 + 1.0W4	-239	-322	0	-NA-	-NA-	-NA-
G107	D	0	0	0	-NA-	-NA-	-NA-
G107	W1	-543	-730	0	-NA-	-NA-	-NA-
G107	W2	-486	-654	0	-NA-	-NA-	-NA-
G107	W3	-327	-440	0	-NA-	-NA-	-NA-
G107	W4	-247	-333	0	-NA-	-NA-	-NA-
G108	0.9D1 + 1.0W1	0	0	0	-NA-	-NA-	-NA-
G108	0.9D1 + 1.0W2	0	0	0	-NA-	-NA-	-NA-
G108	0.9D1 + 1.0W3	412	-554	0	-NA-	-NA-	-NA-
G108	0.9D1 + 1.0W4	363	-488	0	-NA-	-NA-	-NA-
G108	D	0	0	0	-NA-	-NA-	-NA-
G108	W1	0	0	0	-NA-	-NA-	-NA-
G108	W2	0	0	0	-NA-	-NA-	-NA-
G108	W3	421	-566	0	-NA-	-NA-	-NA-
G108	W4	371	-499	0	-NA-	-NA-	-NA-
G109	0.9D1 + 1.0W1	-96	-129	96	-NA-	-NA-	-NA-
G109	0.9D1 + 1.0W2	-374	-503	374	-NA-	-NA-	-NA-
G109	0.9D1 + 1.0W3	0	0	0	-NA-	-NA-	-NA-
G109	0.9D1 + 1.0W4	0	0	0	-NA-	-NA-	-NA-
G109	D	0	0	0	-NA-	-NA-	-NA-
G109	W1	-318	-428	318	-NA-	-NA-	-NA-
G109	W2	-369	-496	369	-NA-	-NA-	-NA-
G109	W3	0	0	0	-NA-	-NA-	-NA-
G109	W4	0	0	0	-NA-	-NA-	-NA-
G110	0.9D1 + 1.0W1	0	0	0	-NA-	-NA-	-NA-
G110	0.9D1 + 1.0W2	0	0	0	-NA-	-NA-	-NA-
G110	0.9D1 + 1.0W3	-0	-170	127	-NA-	-NA-	-NA-
G110	0.9D1 + 1.0W4	0	0	0	-NA-	-NA-	-NA-
G110	D	0	0	0	-NA-	-NA-	-NA-
G110	W1	0	0	0	-NA-	-NA-	-NA-
G110	W2	0	0	0	-NA-	-NA-	-NA-
G110	W3	-0	-183	136	-NA-	-NA-	-NA-
G110	W4	0	0	0	-NA-	-NA-	-NA-
G111	0.9D1 + 1.0W1	0	0	0	-NA-	-NA-	-NA-
G111	0.9D1 + 1.0W2	0	0	0	-NA-	-NA-	-NA-
G111	0.9D1 + 1.0W3	27	-36	27	-NA-	-NA-	-NA-
G111	0.9D1 + 1.0W4	0	0	0	-NA-	-NA-	-NA-
G111	D	0	0	0	-NA-	-NA-	-NA-
G111	W1	0	0	0	-NA-	-NA-	-NA-
G111	W2	0	0	0	-NA-	-NA-	-NA-
G111	W3	30	-40	30	-NA-	-NA-	-NA-
G111	W4	0	0	0	-NA-	-NA-	-NA-

Nodal Extreme Displacements

Node	DX		DY		DZ	
	in	in	in	in	in	in
N105	-0.010 (9)		-0.016 (9)		-0.042 (7)	
N415	-0.054 (4)		-0.004 (5)		0.000 (1)	
N415	0.166 (7)		0.009 (2)		0.051 (9)	
P102	-0.012 (9)		-0.124 (7)		-0.002 (7)	
P102	0.120 (7)		0.213 (4)		0.086 (9)	



TopTec Events Tents
7601 Highway 221
Moore, SC. 29369
(800) 845-2830
(864) 804-5901
www.toptecproducts.com

This page intentionally left blank

